

FMMT493-HF (NPN)

RoHS Device
Halogen Free

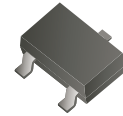

Features

- Low saturation voltage.
- High hFE Max. 300@250mA.
- $I_c = 1A$.

Mechanical data

- Case: SOT-23, molded plastic.
- Mounting position: Any.

Circuit Diagram

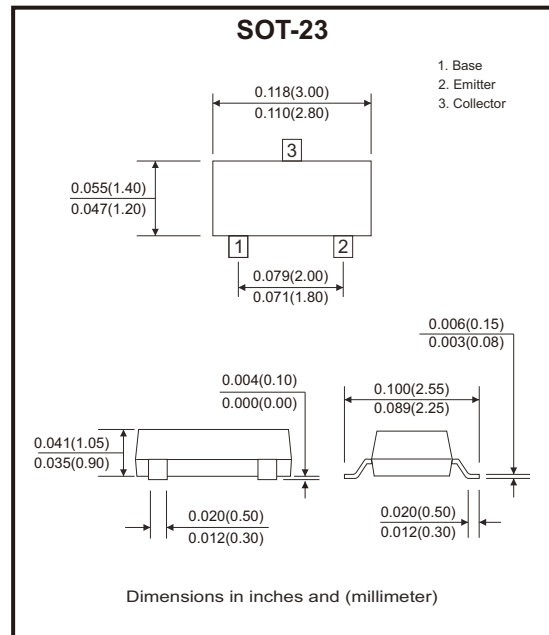
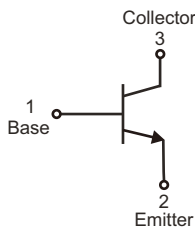

Maximum Ratings (at $T_A=25^\circ\text{C}$ unless otherwise noted)

Parameter	Symbol	Value	Unit
Collector-base voltage	V_{CBO}	120	V
Collector-emitter voltage	V_{CEO}	100	V
Emitter-base voltage	V_{EBO}	5	V
Collector current	I_c	1000	mA
Collector power dissipation	P_c	250	mW
Thermal resistance from junction to ambient	$R_{\theta JA}$	500	$^\circ\text{C/W}$
Operation junction and storage temperature range	T_J, T_{STG}	-55 to +150	$^\circ\text{C}$

Electrical Characteristics (at $T_A=25^\circ\text{C}$ unless otherwise noted)

Parameter	Conditions	Symbol	Min	Typ	Max	Unit
Collector-base breakdown voltage	$I_C = 100\mu\text{A}$, $I_E = 0$	$V_{(BR)CBO}$	120			V
Collector-emitter breakdown voltage	$I_C = 10\text{mA}$, $I_B = 0$	$V_{(BR)CEO}$	100			V
Emitter-base breakdown voltage	$I_E = 100\mu\text{A}$, $I_C = 0$	$V_{(BR)EBO}$	5			V
Collector cut-off current	$V_{CB} = 100\text{V}$, $I_E = 0$	I_{CBO}			0.1	μA
Collector cut-off current	$V_{CES} = 100\text{V}$, $I_E = 0$	I_{CES}			0.1	μA
Emitter cut-off current	$V_{EB} = 4\text{V}$, $I_C = 0$	I_{EBO}			0.1	μA
DC current gain (Note 1)	$V_{CE} = 10\text{V}$, $I_C = 1\text{mA}$	$h_{FE(1)}$	100			
	$V_{CE} = 10\text{V}$, $I_C = 250\text{mA}$	$h_{FE(2)}$	100		300	
	$V_{CE} = 10\text{V}$, $I_C = 0.5\text{A}$	$h_{FE(3)}$	60			
	$V_{CE} = 10\text{V}$, $I_C = 1\text{A}$	$h_{FE(4)}$	20			
Collector-emitter saturation voltage (Note 1)	$I_C = 500\text{mA}$, $I_B = 50\text{mA}$	$V_{CE(sat)1}$			0.3	V
	$I_C = 1\text{A}$, $I_B = 100\text{mA}$	$V_{CE(sat)2}$			0.6	V
Base-emitter saturation voltage (Note 1)	$I_C = 1\text{A}$, $I_B = 100\text{mA}$	$V_{BE(sat)}$			1.15	V
Base-emitter voltage (Note 1)	$V_{CE} = 10\text{V}$, $I_C = 1\text{A}$	V_{BE}			1	V
Transition frequency	$V_{CE} = 10\text{V}$, $I_C = 50\text{mA}$, $f = 100\text{MHz}$	f_T	150			MHz
Collector output capacitance	$V_{CB} = 10\text{V}$, $I_E = 0$, $f = 1\text{MHz}$	C_{ob}			10	pF

Note: 1. Pulse test: pulse width $\leq 300\mu\text{s}$, duty cycle $\leq 2.0\%$.

Rating and Characteristic Curves (FMMT493-HF)

Fig.1 - Static Characteristic

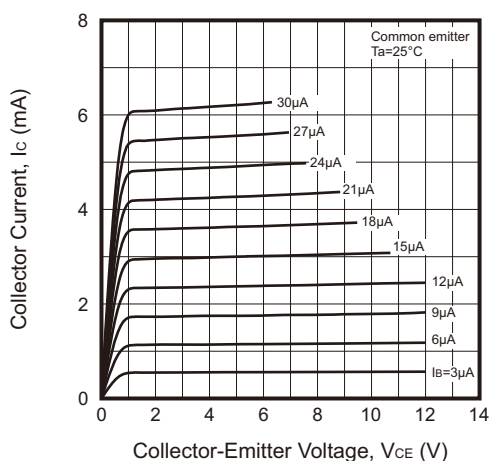
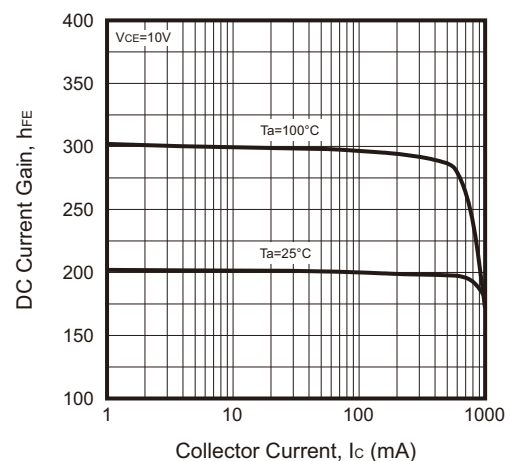

Fig.2 - $h_{FE} - I_C$



Rating and Characteristic Curves (FMMT493-HF)

Fig.3 - V_{BEsat} — I_c

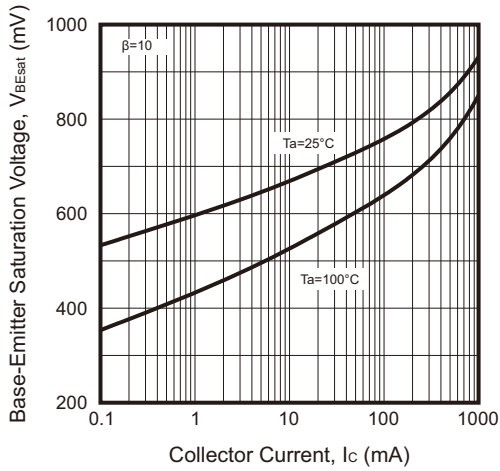

Fig.4 - V_{CEsat} — I_c

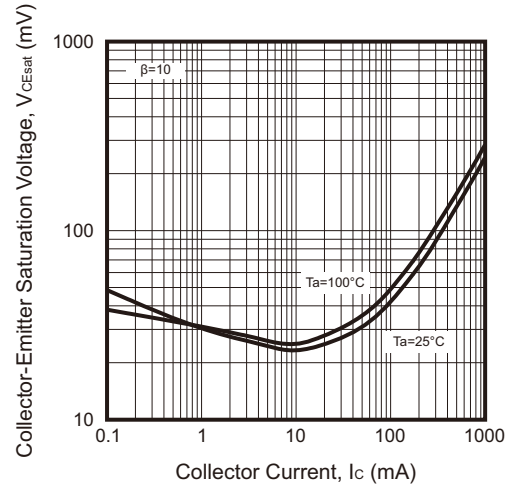

Fig.5 - f_r — I_c

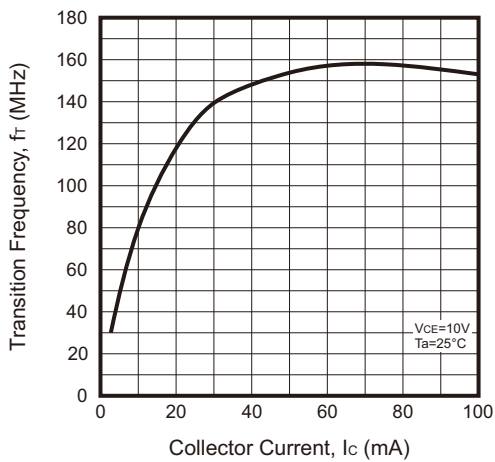

Fig.6 - I_c — V_{BE}

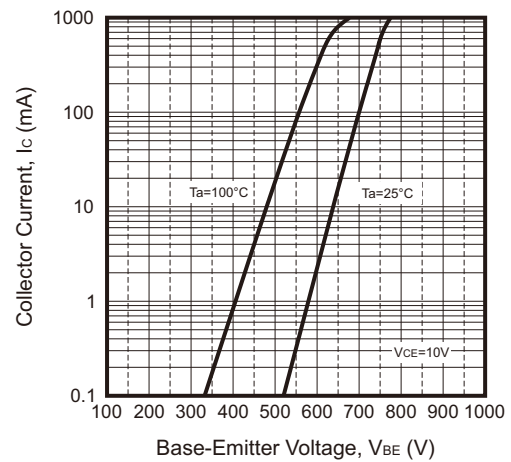
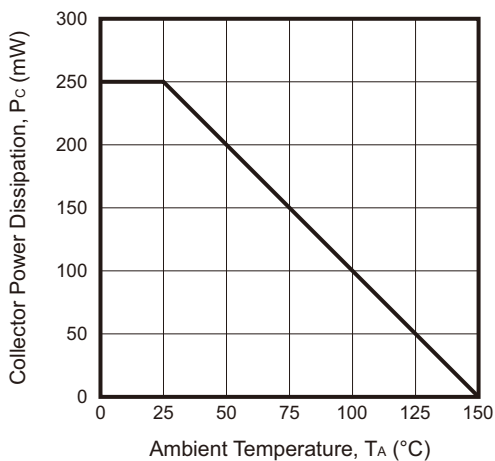
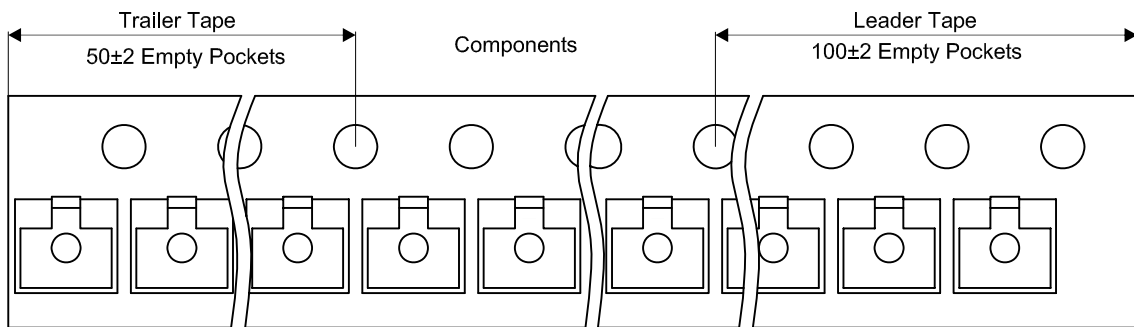
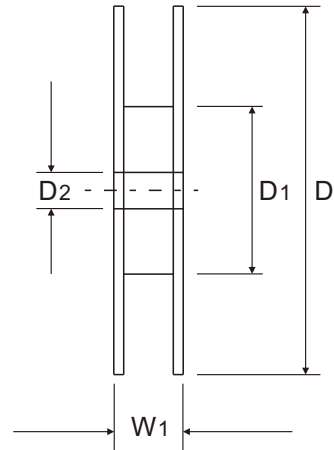
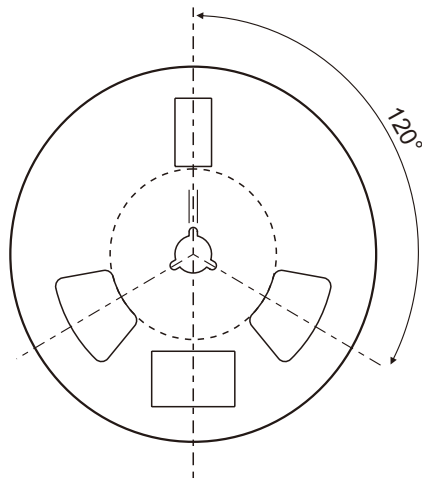
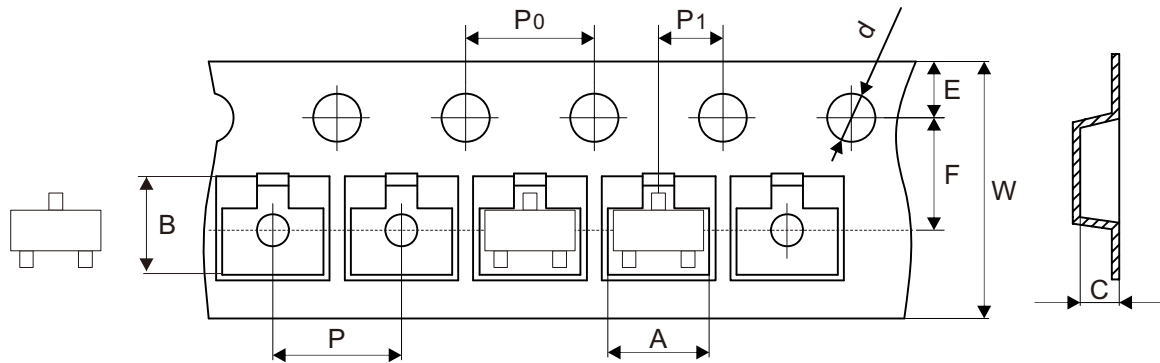

Fig.7 - P_c — T_A



Reel Taping Specification



SOT-23	SYMBOL	A	B	C	d	D	D1	D2
	(mm)	3.15 ± 0.10	2.77 ± 0.10	1.22 ± 0.10	1.50 ± 0.10	178.00 ± 2.00	54.40 ± 1.00	13.00 ± 1.00
	(inch)	0.124 ± 0.004	0.109 ± 0.004	0.048 ± 0.004	0.059 ± 0.004	7.008 ± 0.079	2.142 ± 0.039	0.512 ± 0.039

SOT-23	SYMBOL	E	F	P	P0	P1	W	W1
	(mm)	1.75 ± 0.10	3.50 ± 0.10	4.00 ± 0.10	4.00 ± 0.10	2.00 ± 0.10	8.00 + 0.30 - 0.10	12.30 ± 1.00
	(inch)	0.069 ± 0.004	0.138 ± 0.004	0.157 ± 0.004	0.157 ± 0.004	0.079 ± 0.004	0.315 + 0.012 - 0.004	0.484 ± 0.039

Marking Code

Part Number	Marking Code
FMMT493-HF	493

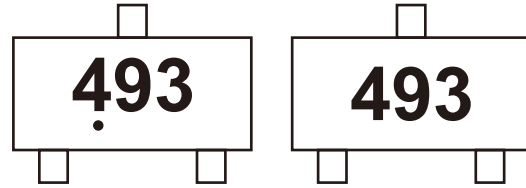

Solid dot = Control code

Suggested P.C.B. PAD Layout

SIZE	SOT-23	
	(mm)	(inch)
A	0.90	0.035
B	0.80	0.031
C	0.95	0.037
D	2.00	0.079
E	2.90	0.114

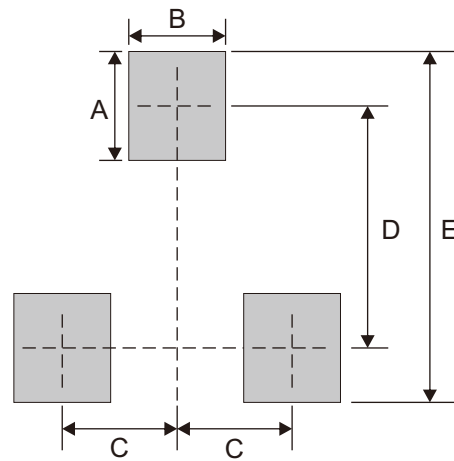

Note: 1. The pad layout is for reference purposes only.

Standard Packaging

Case Type	REEL PACK	
	REEL (pcs)	Reel Size (inch)
SOT-23	3,000	7